



**emium**<sup>™</sup>  
*emium lighting, see differently*

# HAZARDOUS LOCATIONS LIGHT SPECIFICATION



**I Series**



**RoHS**

[www.emium.com](http://www.emium.com)

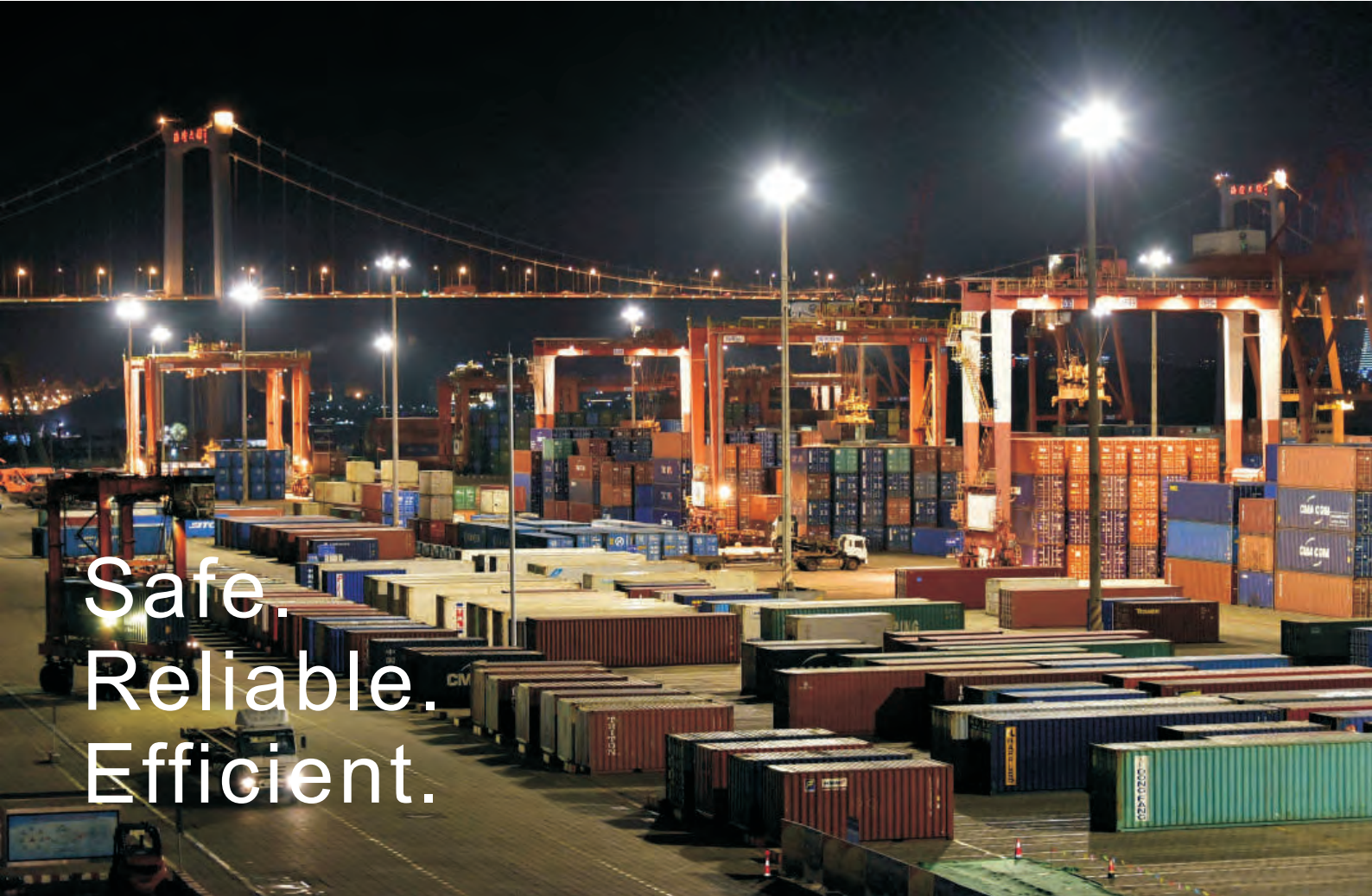

## Applications

This luminaire can be used as flood light, wall pack and area light which can provide general illumination in hazardous locations, such as:

- Oil Refineries & Fuel Depots
- Marine Vessels
- Chemical Production & Processing
- Grain Processing
- Mines
- Distilleries
- Other high humidity, high temperature, dusty locations

## Professional Light Distribution

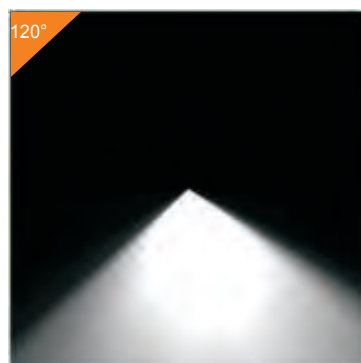
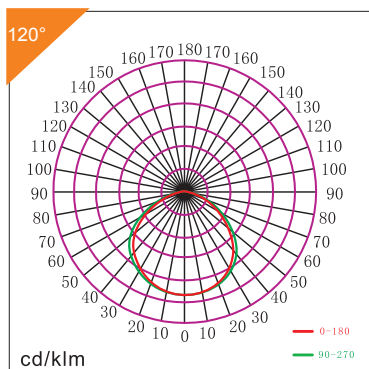

## Typical model specification

Product Number	Wattage	CCT	Voltage	Lumens	Working Hours	CRI
EL-HZ-30W I2YZD	30W	4000K-5700K	AC100-277/200-480V	4200	5 years	70
EL-HZ-40W I2YZD	40W	4000K-5700K	AC100-277/200-480V	5600	5 years	70
EL-HZ-60W I4YZD	60W	4000K-5700K	AC100-277/200-480V	8400	5 years	70
EL-HZ-80W I4YZD	80W	4000K-5700K	AC100-277/200-480V	11200	5 years	70

"I"=Product series "Y"=D or N:Dimmable or non-dimmable "Z"= CCT, from 4000~5700K "D"=Beam angle:120°

## Features

- High efficacy: up to 140lm/W
- CRI>70
- Surface mounting and pendant installation
- Wide and narrow optics for uniform illumination
- Copper free aluminum
- High vibration resistance

## Mechanical information

	Size (in)	Size (in)
AC100-277V models	24x5.5x8.1	47x5.5x8.1
AC200-480V models	24x5.5x8.1	47x5.5x8.1

## Structure diagram

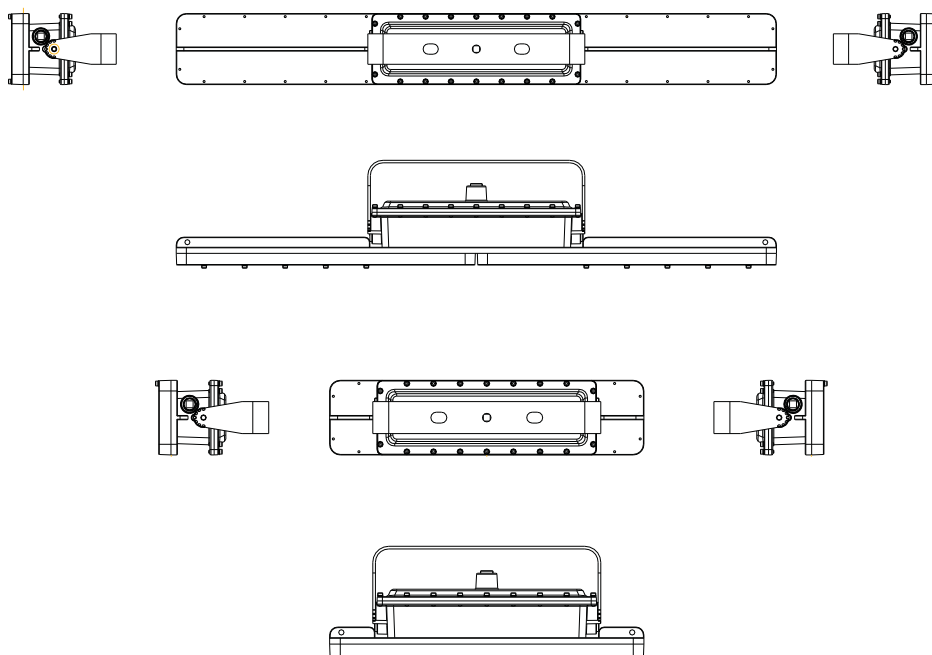

## Mounting method

Explosion proof light can be surface and pendant mounted by bringing down a rigid conduit to the light fixture.

Mounting Option Note:

Pendant mounting option requires conduit be supplied by the installer.

### Rectangle luminaire mounting

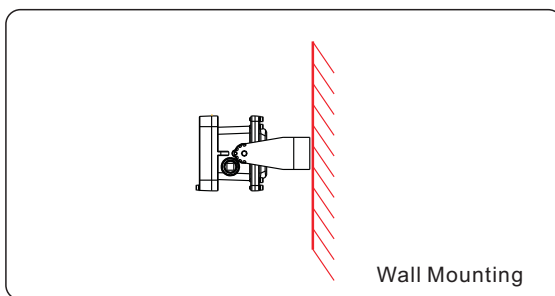
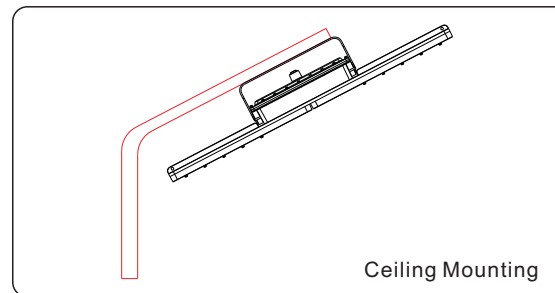
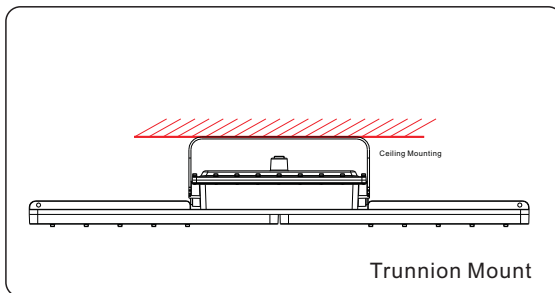
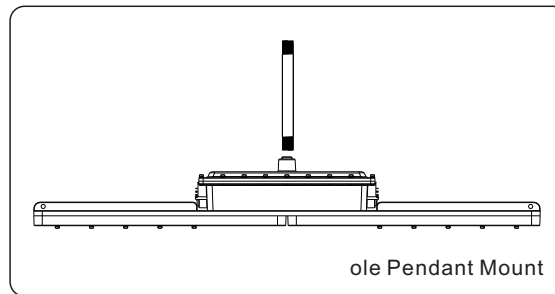
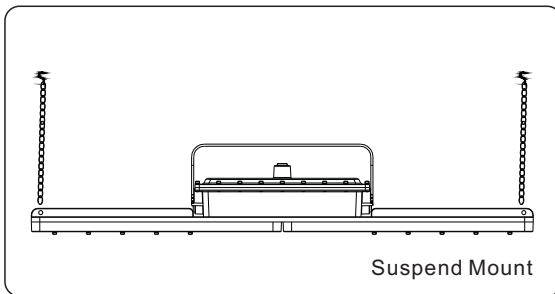

## Warranty

5 year product warranty from the date of purchase:

- Invoice or shipment bill is required to claim the warranty.
- The warranty policy only requires manufacturer to repair the defective product or send substitute for replacement.
- Installation labor, electricity cost and other related cost will not be covered by the manufacturer warranty policy.
- Warranty doesn't cover the defect caused by inappropriate use, especially if directions of the instructions for use are not observed, normal abrasion as well as failures which affect the value or use of the product insignificantly.